

# Granule Maxi®

User Manual



**GRANULDISK®**

Art. no EN16295

Granuldisk AB retains the right to make technical changes to the products.

No responsibility is taken for any printing errors.

[www.granuldisk.com](http://www.granuldisk.com)

Tel. +46 40 671 50 60



---

# Contents

---

EC DECLARATION OF CONFORMITY FOR MACHINERY	5
1 General Description and Safety	7
1.1 To the user	7
1.2 Safety regulations	8
1.3 Technical data	10
1.4 PowerGranules® and PowerGranules BIO®	14
1.5 SIMpel™— easy access to information	15
2 Operating	17
2.1 Start up procedure	17
2.2 Loading wash ware	20
2.3 Control panel	25
2.4 Start and operation	26
2.5 Language selection	29
2.6 Set date and time	30
3 Daily cleaning	31
3.1 Collecting and cleaning of PowerGranules	31
3.2 Cleaning inside the machine	33
3.3 Over night and at longer stoppages	37
3.4 GD Memo™	38
4 HACCP Hygiene and Operation Documentation	41
4.1 General	41
4.2 Reading the data through the control panel	42
4.3 Accumulated values for electricity and water consumption	43
4.4 Download of operation data from USB Port	44
4.5 Optional EcoExchanger®	45
5 Trouble shooting and alerts	47
5.1 User related notices	47
5.2 Error codes	49
6 Notes	53



---

# EC DECLARATION OF CONFORMITY FOR MACHINERY

---

Original

Directive 2006/42/EC, Annex II 1A

**Manufacturer (and where appropriate his authorised representative):**

Company: Granuldisk  
Address: Jägershillsgatan 13, 213 75 Malmö

**Hereby declares that**

Type of machinery: Granule pot washing machine for  
commercial kitchens  
No. of machinery: Granule Maxi®

**Complies with the requirements of Machinery Directive 2006/42/EC.**

**Complies with the applicable requirements of the following EC  
directives:**

2014/30/EU, EMC

2011/65/EU, WEEE

2012/19/EU, RoHS

**The following harmonized standards have been applied:**

EN 60204-1:2018

SS-EN 60335-1:2012

SS-EN 60335-2-58:2019

SS-EN 55014-1:2017

SS-EN IEC 61000-6-1:2019

SS-EN IEC 61000-6-2:2019

SS-EN 61000-6-3:2007

IEC 61000-6-3:2006/AMD1:2010

**The following other standards and specifications have been applied:**

SS-EN 1717:2000

SS-EN 13077:2018

**Authorized to compile the technical file:**

Name: Staffan Stegmark  
Address: Jägershillsgatan 13, 213 75 Malmö

**Signature:**

Place and date: Malmö, 26.04.2021  
Signature:



Name: Mikael Samuelsson  
Position: CEO



---

# 1 General Description and Safety

---

## 1.1 To the user

Granule Maxi® is a Granule pot washing machine for commercial kitchens that is designed for washing pots and pans.

This manual is your guide for the correct use of the Granule Maxi® pot washing machine.

Granuldisk recommends that you study the manual thoroughly to be sure that the machine is installed and used correctly and safely.

Ensure that the manual is always available during the whole lifetime of the machine.

Granuldisk accepts no responsibility for damage to the equipment or other damage or injury caused by not following the directions in this manual.

User manual in original.

## 1.2 Safety regulations



### **NOTE**

*Read the safety notes and operating instructions in this manual carefully. Keep the operating instructions for future reference. Granuldisk does not assume liability or warranty in case of non-adherence to these safety and operating instructions.*

*Do not make changes, additions or reconstructions in the pot washer without the approval of the manufacturer. Use the pot washer only after you have read and understood the user manual. Allow Granuldisk to provide information about the operation and functioning of the pot washer.*

*Always operate the machine as described in these operating instructions. Train the operating personnel about handling of the machine and inform them about the safety notes. Repeat the training sessions at regular intervals to prevent accidents.*

For your safety, test the local fault current circuit breaker (FI) regularly by pressing the test button.

Close the on-site water shut-off valve after the work is complete. Switch off the local mains disconnecter after the work is complete.

The composite material in the granules is approved for use in conjunction with food.



### **WARNING**

*The machine uses hot water. Avoid contact with the skin as there is a scalding risk!*



### **WARNING**

*Do not open the doors during a wash cycle! Risk of burn.*



### **WARNING**

*There is a risk of slipping if granules are left on the floor.*



**WARNING**

*Formaldehyde, which is dangerous if inhaled, may be formed if the original granules made of POM plastics, catch fire. Does not apply for the PowerGranules BIO.*

**NOTE**

*Regarding the handling and use of detergent and rinse aid with the product, please see the chemical manufacturer's instructions. Use high quality products for best wash result. Also refer to information about detergent and rinse aid in the Service manual.*

## 1.3 Technical data

### GENERAL

Design	Front loaded with two doors
External dimensions	2039 ( $\pm$ 25 mm) x 1452 x 1075 mm (H x W x D) closed without EcoExchanger
Weight	666 kg (filled machine) 485 kg (empty machine)
Tank volume	165 liter
Loading volume	450 litres 1060 x 540 x 680 mm (H x W x D)
Rinse water volume	7 litres (ECO program) 14 litres (Short/Normal program) To achieve 3600 HUE according to NSF/ANSI 3 hygiene guidelines, 14 litres is necessary.
Granule amount	16 litres
Wash water temperature	65 °C
Rinse water temperature	85 °C
Sound pressure level	< 70 dB (A)

### PROGRAMS & CAPACITY

Wash programs with granules	Eco: 2 min, 40 sec (+95 sec w EcoExchanger)  Short: 4 min, 50 sec (+60 sec w Steam reduction or +120 sec w EcoExchanger)  Normal: 6 min, 50 sec (+60 sec w Steam reduction or +120 sec w EcoExchanger)
-----------------------------	---

Wash programs without granules	Eco: 2 min, 40 sec (+95 sec w EcoExchanger®) Short: 3 min, 40 sec (+60 sec w Steam reduction or +120 sec w EcoExchanger) Normal: 5 min, 40 sec (+60 sec w Steam reduction or +120 sec w EcoExchanger)
Max. / normal capacity per hour (normal capacity incl. handling)	Compact edition: 176/128 GN 1/1 Flow edition: 176/136 GN 1/1 Free flow edition: 176/152 GN 1/1
Capacity per program	8 GN 1/1 or 16 GN 1/2 up to max 200 mm depth, or similar in other pots.

### ELECTRICAL CONNECTION

Voltage**	3~ 400-415V/50 Hz or 60 Hz + PE 3~ 200V/50 Hz or 60 Hz + PE 3~ 208V/60 Hz + PE 3~ 230V/50 Hz or 60 Hz + PE 3~ 380V/50 Hz or 60 Hz + PE 3~ 440V/50 Hz or 60 Hz + PE 3~ 480V/60 Hz + PE 3~ 575V/60 Hz + PE
Fuse (at output 21.0 kW)	40A (400V, 415V, 380V, 440V) 63A (230 V)
Fuse (at output 29 kW)	50A (400 V, 415 V, 380 V, 440 V)
Fuse (at output 5 kW)	20A (400 V, 415 V, steam heated) 25A (230V, steam heated)
Fuse (at output 6.6 kW)	16A (575V, steam heated)
Fuse (at output 18 kW)	63A (200V, 208V)
Fuse (at output 22.6 kW)	32A (575V) 40A (480V)
Frequency	50 Hz or 60 Hz

Maximum output	21 kW (hot fill) 29 kW (cold fill or hot fill) 5 kW (steam heated) 6,6 kW (steam heated, 575V) 18 kW (hot fill, 200V, 208V) 22,6 kW (hot fill, 480V, 575V)
Wash pump motor	2 x 2,2 kW 2 x 3,0 kW (480V, 575V)
Rinse pump motor	0,37 kW
Heater wash tank*	13 kW at output 18 kW 16 kW at output 21 kW 16 kW at output 22,6 kW 24 kW at output 29 kW
Heater rinse tank*	13 kW at output 18 kW 16 kW at output 21 kW 16 kW at output 22,6 kW 24 kW at output 29 kW
Enclosure rating	IPX5

---

### WATER CONNECTION

Hardness/Connection	Total hardness: 3-7 °dH, 5-12 °TH, 53-125 PPM  ¾" BSP male (DN20)
Connection A	1-6 bar, 25 l/min, 5-65 °C (hot or cold fill)  NB! Reverse osmosis water and totally softened water must not be used.
Connection B	Steam reduction: 3-6 bar 15 l/min), < 20°C  EcoExchanger (option): 3-6 bar 15 l/min), < 20°C

---

### VENTILATION & DRAIN

Ventilation with steam reduction	300 m³/h
----------------------------------	----------

Ventilation without steam reduction	900 m <sup>3</sup> /h
Ventilation with EcoExchanger	150 m <sup>3</sup> /h
Heat emitted to room with steam reduction (total/sensible/latent)	2.7 kW / 1.0 kW / 1.7 kW
Heat emitted to room without steam reduction (total/sensible/latent)	4.9 kW / 1.0 kW / 3.9 kW
Heat emitted to room with EcoExchanger	2.0 kW / 1.0 kW / 1.0 kW
Drainage pipe	Pipe Ø 32 mm (outer diameter)
Drain	Capacity requirement 50 l/min No drain pump, gravity drain The machine must not be placed directly over a drain.

**DETERGENT & RINSE AID**

Detergent and rinse aid	Required. 230 VAC signal is available from separate box Max load total 0,5 A
-------------------------	---

\* Not in use simultaneously.

\*\* For specific data regarding delivered machines, please see machine rating plate.

**NOTE**

*Granule Maxi® is supplied with a 2 metres long electric cable to be connected to an approved supply disconnecting device on the wall. The supply disconnecting device is not included in the delivery.*

## 1.4 PowerGranules® and PowerGranules BIO®

- PowerGranules and PowerGranules BIO are specially designed to work with Granule pot and pan washing machines from Granuldisk.
- They ensure the best wash result as well as the longest working life both for themselves and the machine.
- The composite material in the PowerGranules is approved for use in conjunction with food.
- The PowerGranules BIO is a biodegradable granule.

### Collection of PowerGranules as part of daily cleaning

- Insert your Granule collector in the machine as per instructions in Daily cleaning section of this manual.
- Choose a "Granule collection program" by pressing "STOP", waiting 3 seconds, then press & hold Granule button and Short program button until the text "Granule collecting program" appears in the display.
- For a spotless clean wash result, check the recommended level (total of 16 litres; 8 litres in each Granule collector) of granules every day when collecting the PowerGranules. **Top up with PowerGranules if the level goes under the horizontal level mark.**

See Fig. 21 *Check Granule level*

- Do not mix PowerGranules and PowerGranules BIO® in the machine. Technically there will be no harm to the potwasher, however the waste management is different (see below) and therefore we recommend exchanging the whole batch of granules when switching to PowerGranules BIO®.

### Exchange of worn out PowerGranules

- Please follow the recommended exchange of PowerGranules communicated by the GDMemo™ (message occurs every 2 500 Granule cycles). Run a Granule collection program as per above and replace with a new batch.
- After exchanging the granules, reset the reminder by pressing the STOP button, wait for 3 seconds, then press the Granule button 5 times. OK is shown in the display during 2 seconds after the reset.
- Worn out granules should be handled as non-hazardous waste. Used granules should be sealed in a plastic bucket with a lid or in a plastic bag before being disposed of. PowerGranules can be sorted as recyclable plastic or combustible waste. PowerGranules BIO® should be sorted as combustible waste or according to local regulations. PowerGranules BIO® is biodegradable and therefore cannot be recycled as plastic.

## 1.5 SIMpel™— easy access to information

To make it easier for the operator to find information about the machine and how to use it, there is a QR-code on the machine.

The sticker is placed under or at the side of the display.



- 1 Scan the QR code on the sticker.

See Fig. 1 *QR-code on the sticker*

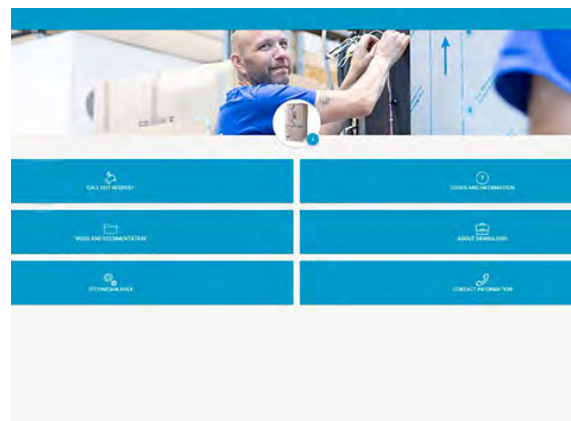

**Fig. 1 QR-code on the sticker**

- 2 When you scan the QR code, you enter the following menu.

(Note that the interface may vary depending on the device used).

See Fig. 2 *Menu*



**Fig. 2 Menu**

3 Select the language in the upper right corner. English is default.

**Explanation of the different boxes:**

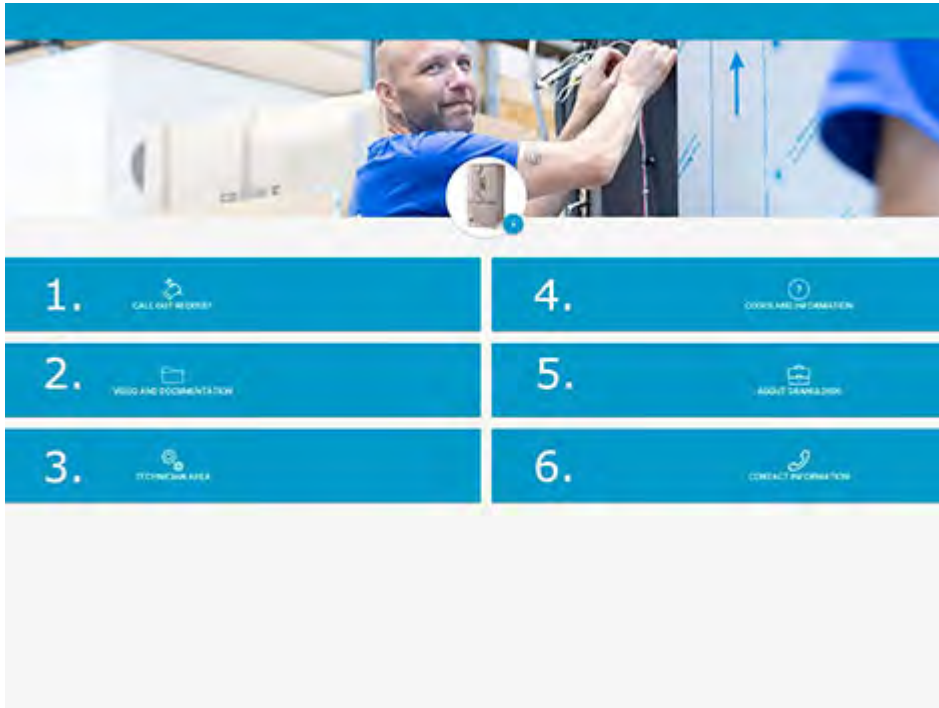

1. CALL OUT REQUEST	Make a service call on the machine
2. VIDEO AND DOCUMENTATION	User manuals and videos of accessories/ daily cleaning
3. TECHNICIAN AREA	Only for technicians/service partners
4. CODES AND INFORMATION	List of error codes
5. ABOUT GRANULDISK	Link to our website
6. CONTACT INFORMATION	Contact information to service partner



---

## 2 Operating

---

### 2.1 Start up procedure

- 1 Fill the machine with the right amount of PowerGranules from the Granule Collectors.

There are two Granule Collectors with 8 liters of granules each.

Empty both of them in the machine.

See Fig. 3 *Granule filling*



**Fig. 3 Granule filling**

- 2 Close the drain valve on the front of the machine

See Fig. 4 *Drain valve*

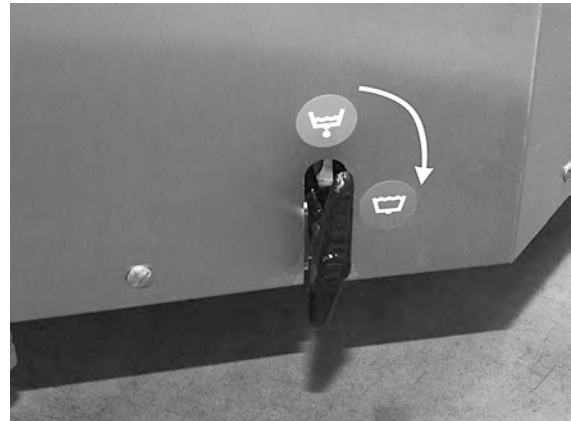
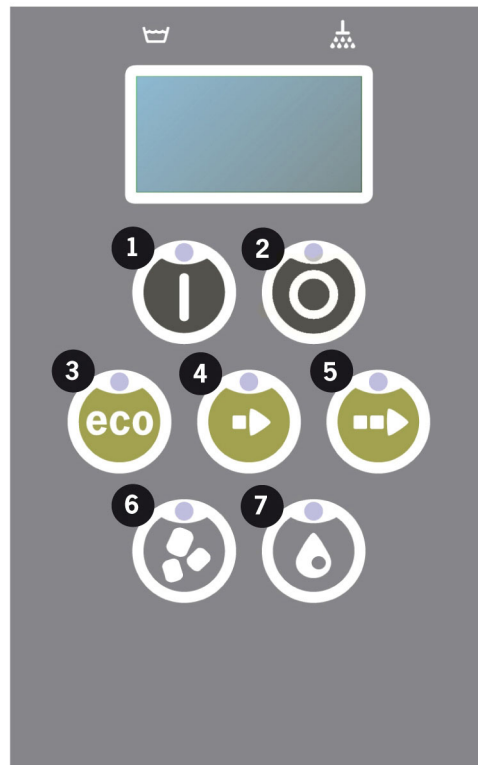

**Fig. 4 Drain valve**

- 3 Switch on the main electrical switch.

## Filling with water

- 1 Close the doors



- 2 Press the Confirm (1) button in order to fill the wash tank.

Fill wash tank?

- 3 The program selection diodes flash out of sequence with the diodes for washing with or without granules during filling.

XX °C    XX°C  
Filling the wash  
tank

- 4 Filling and heating takes about 20 minutes (hot water connection, +55 °C). For optional cold water connection (+10 to 12 °C), filling and heating take about 40 minutes. If the correct temperature has not been attained in the wash tank after filling, the following message is displayed:

50°C    60°C  
Heating the  
wash tank, 65°C

- 5 Ready to use when the correct temperature has been attained in the wash tank.

A pre-selected program is now displayed;

65°C    70°C  
Eco program  
with granules  
wash time: 2:40



#### **NOTE**

*RED LAMP; indicates that the machine is working. Do not open the door!*

*GREEN LAMP; indicates that the machine is ready for use*

### **Preparing utensils**

- 1 Empty and scrape off all food remains before loading the utensils

See Fig. 5 *Scrape off food*

- No soaking or scrubbing is needed.
- No usage of hand-soap or similar (to avoid foaming which could lead to extended problems).



**Fig. 5 Scrape off food**

- 2 Pots and pans containing moist protein-rich food remains may need a splash of water before being loaded into the machine.

## 2.2 Loading wash ware

### How to load the wash ware

All utensils must be loaded with the inside facing the spray nozzles.

See Fig. 6 *Loading utensils*

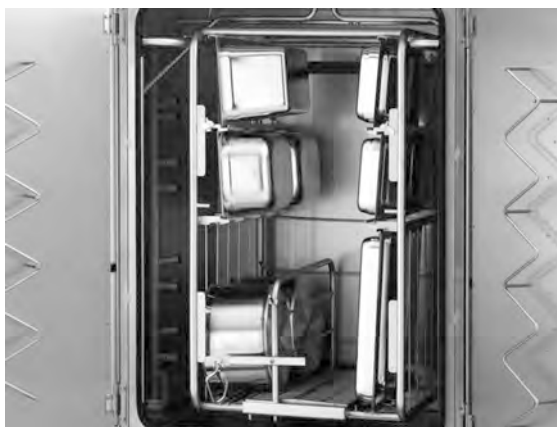

**Fig. 6 Loading utensils**

### Inserting and removing the cassette

#### **Granule Maxi, Compact Edition:**

The cassette is an integral part of the machine and can be slid halfway out of the machine.

#### **Granule Maxi, Flow Edition:**

Roll the trolley up to the loaded cassette. Undo the catch and raise the handle. Hook the cassette on by pushing the handle down again.

See Fig. 7 *Hooking the cassette*



**Fig. 7 Hooking the cassette**

The cassette is then rolled into the machine using the trolley. Unhook the cassette by undoing the catch and raising the handle.

The cassette can easily be suspended on the wall hooks next to the machine by following the above instructions in reverse.

**Granule Maxi, FreeFlow Edition:**

The cassette is loaded suspended on the trolley. The cassette is then rolled into the machine using the trolley. Unhook the cassette by undoing the catch and raising the handle.

See Fig. 8 *Trolley catch*

**Multicassette for Maxi Flow and FreeFlow Edition (14469)**

For 8 GN 1/1 or 4 GN 2/1 or the equivalent in other wash ware.

See Fig. 9 *Multi cassette*



**Fig. 8 Trolley catch**

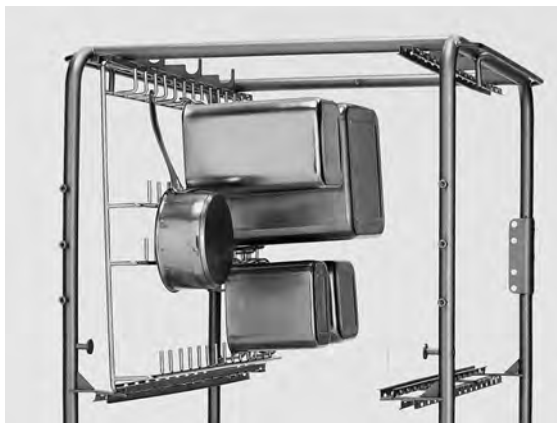

**Fig. 9 Multi cassette**

### Pot- and saucepan holder (10972)

Capacity: 3–5 pots/saucepans with handles or ears to be hung on the hooks.

See Fig. 10 *Pot- and saucepan holder*



**Fig. 10 Pot- and saucepan holder**

### Utensil holder (10362)

For ladles, whisks etc (up to 500 mm). The utensil holder is fitted in one of the upper runners on the cassette.

See Fig. 11 *Utensil holder*



**Fig. 11 Utensil holder**

### Dividers for GN containers, sizes GN 1/9–2/3 (19313)

To allow GN 1/2, 1/3, 1/6, 1/9 and 2/3. The Divider makes it possible to load one of the following combinations:

- 4 x 1/2 GN containers or
- 8 GN 1/4 or
- 2 x 1/3 and 2 x 2/3 GN containers or
- 4 x 1/6 and 2 x 2/3 GN containers or
- 6 x 1/9 and 2 x 2/3 GN containers.

See Fig. 12 *Divider*

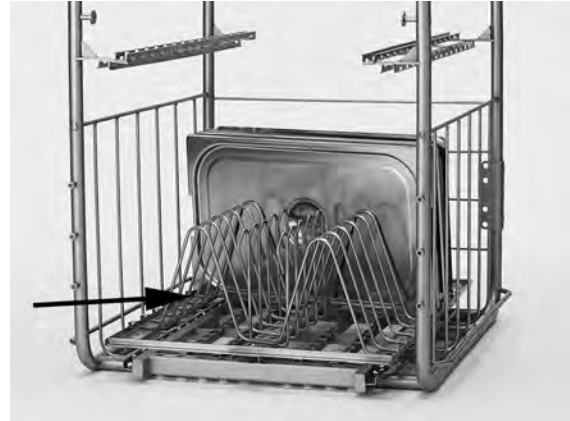

**Fig. 12 Divider**

**Lid- and tray holder (10950)**

Capacity: Up to 9 pc of GN 1/1 sized flat trays and lids. The lid holder is best fitted in the lower cassette runners.

See Fig. 13 *Lid- and tray holder*



**Fig. 13 Lid- and tray holder**

**Holder for small GN pans (10948)**

Capacity: Up to 6 GN 1/3 or 12 GN 1/6 or 18 GN 1/9. The holder is placed in one of the four existing runners on the cassette.

Each row in the holder can take the following combination: 2 x 1/3 or 4 x 1/6 or 6 x 1/9 GN containers.

See Fig. 14 *Holder small GN pans*

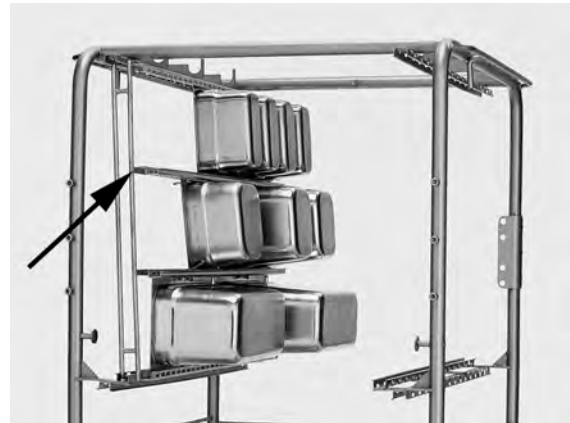

**Fig. 14 Holder small GN pans**

**Netbasket with lid (21477)**

For ladles, whisks up to 500 mm length. Place at the bottom of the cassette, following the runners.

See Fig. 15 *Net basket*



**Fig. 15 Net basket**

**Insert for baking trays (22017)**

Capacity: 8 x 600x400 mm  
baking trays, max 20 mm edge.

See Fig. 16 *Insert for baking  
trays*

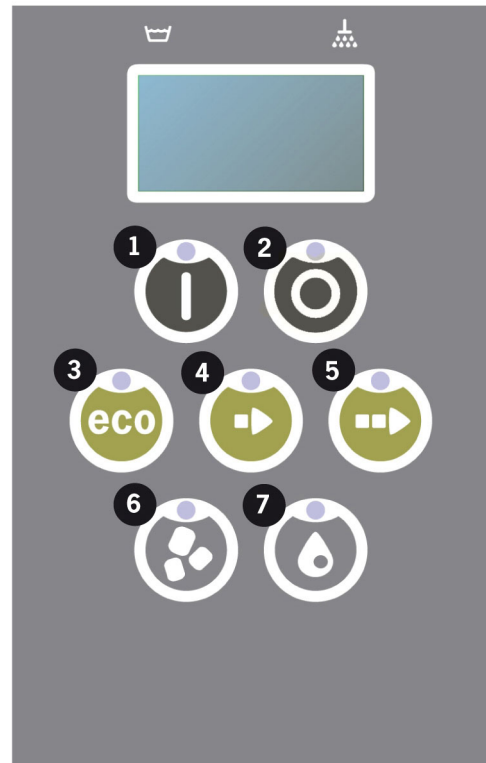

**Fig. 16** *Insert for baking trays*



## 2.3 Control panel

- 1 Confirm button is used to answer "yes" to a question shown in the display window



- 2 The Stop button is used to reset potential alarms.

It is also used to enter sleep mode. After 30 seconds the display light goes out and the machine goes into sleep mode. The Stop button's red diode stays lit during sleep mode, but all functions in the machine are deactivated.

Push any button to reactivate the machine.

**In sleep mode there is no heating of the wash tank or rinse tank.**

- 3 Start ECO program
- 4 Start Short program
- 5 Start Normal program
- 6 Washing with granules
- 7 Washing without granules

## 2.4 Start and operation

### 1 Press the Confirm button (1)

- If temperature is lower than 65 °C in wash tank at the time of the first start, once the wash tank has been filled, the machine will continue heating.
- Washing at a too low temperature increases the risk of foaming and the items not being hygienically clean.
- Reprogramming may be carried out by authorised personnel only.

62°C (blinking) 59°C  
 Heating the  
 wash tank, 65°C

### 2 Select washing with or without granules (6) or (7). For slightly soiled pans, perforated containers, transparent plastic or teflon containers, choose a program without granules. For normal to heavily soiled pots and pans, choose a powerful Granule cycle to blast the utensils clean.

### 3 Select and start required wash time (3), (4) or (5)

#### **ECO**

2 min, 40 sec (with granules)

2 min, 40 sec (without granules)

+95 sec with optional EcoExchanger

#### **Short**

4 min, 50 sec (with granules)

3 min, 40 sec (without granules)

+60 sec with optional steam reduction, or +120 sec with EcoExchanger

#### **Normal**

6 min, 50 sec (with granules)

5 min, 40 sec (without granules)

+60 sec with optional steam reduction, or +120 sec with EcoExchanger

65°C 85°C

Eco program  
 with granules

Time remaining: 2:40

- 4 When the wash program is complete, the word "END" flashes and the green indication lamp goes on.

65 °C      85 °C  
END

See Fig. 17 When the program is finished the green light goes on.



**Fig. 17** When the program is finished the green light goes on.

- 5 When the doors are opened the display goes back into stand-by mode and shows the latest program used.

Eco program  
with granules  
Wash time: 2:40



### WARNING

*Do not open the door during a wash cycle! Risk of burn.*

- 6 Keep the doors closed if you are not running another wash program straight away. It saves energy and reduces evaporation from the wash tank.

### Stopping the machine while in operation

- Switch to washing with water for about 30 seconds in order to rinse off all granules. Then press STOP (2).
- In an emergency: Just press STOP (2).



### NOTE

*Utensils may have remains of detergent and should be washed again before they are taken out of the machine. Never drain an emergency stopped machine! (granules left in the pump without water will jam the pump impeller.)*



### WARNING

*Do not open the door during a wash cycle! Risk of burn.*

### Resetting of overheat protection

Reset overheat protection if error codes 104 and 105 occur.

- 1 Empty the wash tank.
- 2 Clean the level sensor.
- 3 Unscrew the black cap.
- 4 Reset the overheat protection using a small screwdriver to stick into the protector and push the reset button. If the protection has tripped, a click is heard when it is reset.

See Fig. 18 *Access to overheat protectors*

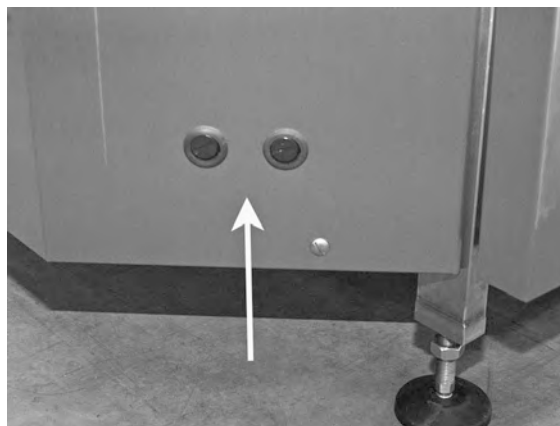

**Fig. 18 Access to overheat protectors**

- 5 If the error code recurs in the next few hours, contact a service engineer.

### Inspecting the wash ware

- 1 Examine the pots and pans after each program.
- 2 To make sure no granules are left, turn all washware (containers, pans etc) upside down, before taking the items out of the machine.
- 3 Remove any granules that may be stuck in corners, sharp angles and other inaccessible places

See Fig. 19 *Make sure no granules are stuck*

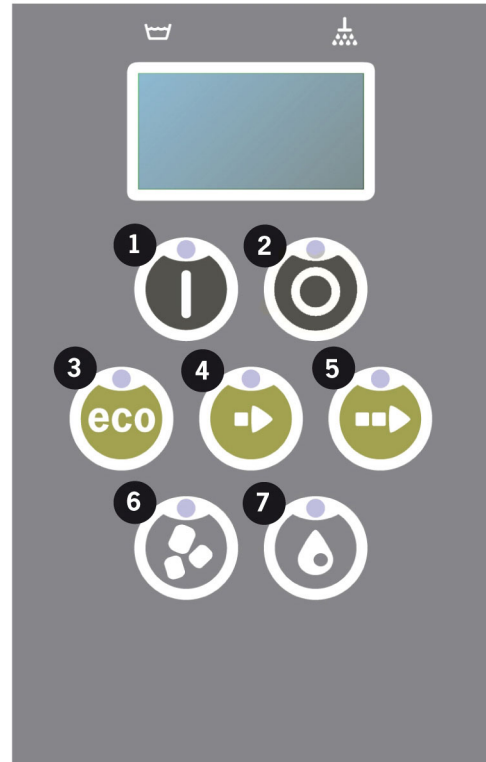

**Fig. 19 Make sure no granules are stuck**

## 2.5 Language selection

To change the language settings:

- 1 Press the STOP button, release it and wait for 3 seconds.



- 2 Press the (4) "Short program" button, five times.

- 3 The display shows the following:

```
Language
< English >
Select Back
```

- 4 Press the Confirm button for "select".

- 5 Scroll using the buttons for ECO(3) or Normal (5) program, to step through the list of languages.

```
Language
< English >
OK Cancel
```

- 6 Select a language by pressing the Confirm button (1); OK.

- 7 Press STOP button (2) to quit programming mode.

## 2.6 Set date and time

To change the date and time:

- 1 Press STOP (2), then press Short program button (4) 5 times and 1 time on ECO program button (3).

Change date and  
time

ddmmyy hh:mm

210101 13:00

Choose Back

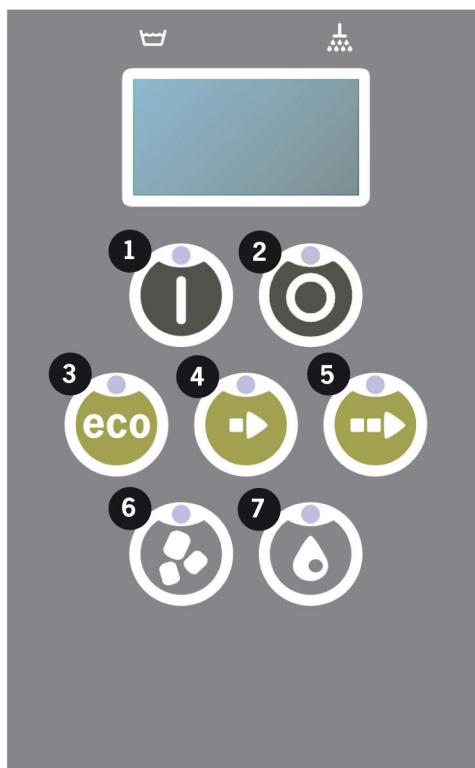

- 2 Press Function button (1) to choose and to be able to change date and time.

Change date and  
time

ddmmyy hh:mm

210101 13:00

OK Cancel

- 3 Adjust date and time by using Normal program button (5) to step to the right. ^^ marks which number can be changed. Use Short program button (4) to change up and Granule button (6) to change down.
- 4 For OK and to save new settings press Function button (1). Use STOP button (2) to quit programming mode without saving.

---

## 3 Daily cleaning

---

### 3.1 Collecting and cleaning of PowerGranules

- 1 Use the Granule Collectors, 2 pcs.



**Fig. 20 Granule collectors in machine**

- 2 Place the Granule Collector in the cassette.

See Fig. 20 *Granule collectors in machine*

- 3 Close the doors and press STOP.

- 4 Wait for 3 seconds. Then press the buttons Short program (4) and granules (6) simultaneously until the display shows "Granule collect program". This program will start to collect all granules in the collector.

65°C 70°C  
Granule collect  
program  
Wash time: 6:10



**NOTE**

*If option EcoExchanger, the Granule collect program is 8:10.*



**NOTE**

*No detergent dosing, no heating of wash or rinse tank will occur during the collecting program.*

- 5 Once the Granule collecting program is complete, a message is shown:

- From 2500 to 501 programs: Check Granule level (after every 10th collection)
- From 500 to 251 programs: No message (goes back to STOP mode)
- From 250 to 1 program: Order granules (after every collection)
- From 0 program: Change granules now (after every collection until message is reset)

Top up with granules when needed. Wash result will suffer if the Granule level is too low.

- 6 Take the filled Granule collector out from the machine and rinse the granules thoroughly. Make sure no food residues are left.
- 7 Check that the Granule level reaches up to the horizontal mark in the Granule collector

See Fig. 21 *Check Granule level*



**Fig. 21 Check Granule level**



**NOTE**

*Not 100% of the granules will be collected. 1–2 deciliters can remain in the tank.*



**NOTE**

*Too many or too few granules will impair wash results. Too many can also cause blocking of the spray nozzles.*



**NOTE**

*Do not use disinfectant or other cleaning products when cleaning the granules. The residue from these products will cause foaming in the machine with poor wash result as a consequence.*



## 3.2 Cleaning inside the machine

- 1 Press STOP button (2).
- 2 Switch off at the main electrical switch.
- 3 Remove and check all 4 spray pipes.

- The spray pipe lock is folded up, then you push the spray pipe up and pull it to one side.
- The spray pipe is pulled down gently and removed from the machine.
- The spray pipe can now be cleaned.

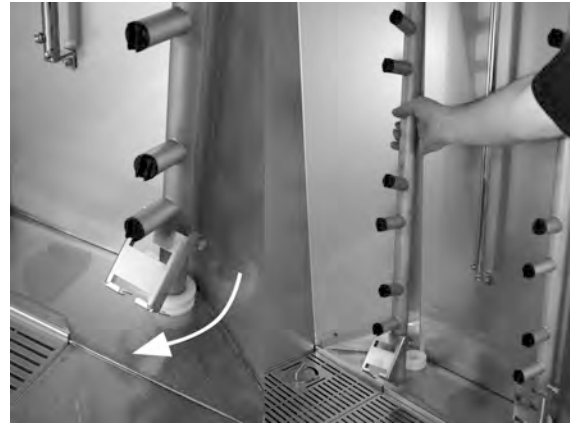
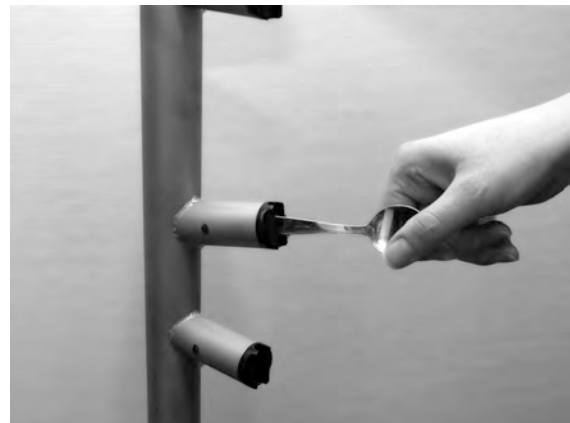

**Fig. 22 Removing spray pipe**

See Fig. 22 *Removing spray pipe*

If any visible piece of e.g chicken bone is seen in the opening of the nozzle, please take the back side of a tea-spoon and carefully put the piece back into the spray pipe. Any pieces stuck will then fall down the spray pipe and out at the end.

See Fig. 23 *Cleaning of spray nozzle*



**Fig. 23 Cleaning of spray nozzle**

- 4 Lift out the overflow sieve (A). Lift out the two tank grids. Clean and flush with water.

See Fig. 24 *Tank grids*

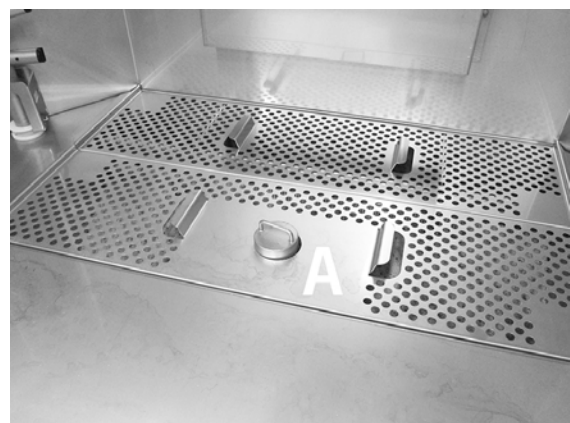
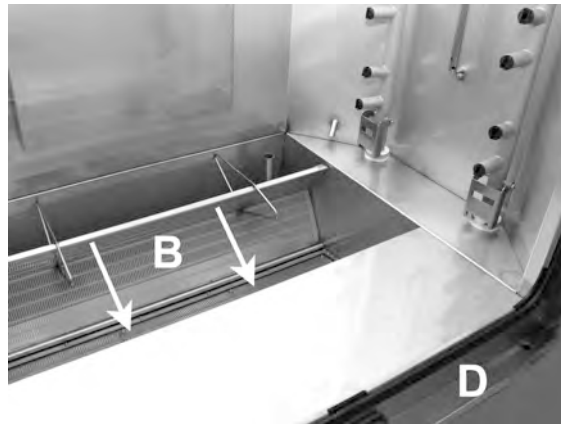

**Fig. 24 Tank grids**

- 5 Move the Granule strainer (B) towards you in order to clean the bottom of the tank.

See Fig. 25 *Granule strainer and drip groove*

- Clean and flush the tank. Rinse with extra care so that the bottom of the tank is also reached.
- Clean the perforated surface (of the Granule strainer) to ensure that there are no granules left there.
- Check that the sealing strip for the Granule strainer is undamaged.



**Fig. 25 Granule strainer and drip groove**

- 6 The drip groove (D) is to be washed clean and dried in order to avoid blockage in the drain channels.

See Fig. 25 *Granule strainer and drip groove*

- 7 Wipe off the level sensor (C) with a clean cloth.

See Fig. 26 *Level sensor*



**Fig. 26 Level sensor**

- 8 Wipe door seals.
- 9 Wipe inside of the doors with a damp cloth.
- 10 The top should be wiped off when required or at least once a month.

- 11 If present, clean and flush the EcoExchanger from the inside of the cabin. (The box on top of the roof will be cleaned by a service technician when servicing the machine – every 10.000 cycle).

When the machine is calling for periodical service (message in display), the interior of the heat exchanger will be cleaned by the service technician doing the regular preventive service.

See Fig. 27 *EcoExchanger*

- 12 For video instructions use the QR code and watch the daily cleaning on Youtube

See Fig. 28 *QR code*



**Fig. 27 EcoExchanger**



**Fig. 28 QR code**



**NOTE**

*The outside of the machine should **not** be washed with high-pressure.*

**Replacement of cleaned items**

- Put the Granule strainer into the right position again.
- Put the two tank grids back.
- Put the overflow sieve back.
- Put the four spray pipes back.



**NOTE**

*If the overflow sieve is not cover is not put back properly, the granules may run down the drain during a wash cycle.*

### 3.3 Over night and at longer stoppages

- Ensure that wash tank is empty after cleaning.
- Leave doors slightly open so that air can circulate in the machine.
- PowerGranules should be stored in Granule collector standing in the machine.
- At longer stoppages, any water remaining at the bottom of the tank should be removed with a sponge or similar absorbent
- After a long stoppage, check operation of the machine according to service manual, possibly with the assistance of a service engineer.

## 3.4 GD Memo™

GD Memo is an integrated function which informs the user of the machine's most important maintenance requirements. With GD Memo, it is possible to ensure optimum wash results, avoid breakdowns during peak hours and maintain the lowest possible operating costs. This function is integrated in the control panel and keeps the user informed as follows:

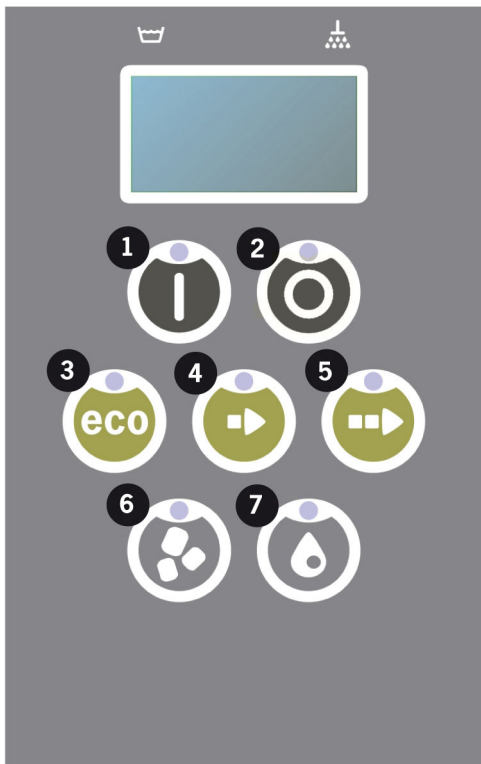

### 1. Time to change wash water

—to ensure a good washing result. The “Washing without granules” button [7] flashes and the message “Change water” is shown in the display. This information disappears automatically once the water has been changed or can be reset by pressing Stop button [2], releasing it, waiting 3 seconds and then pressing button [7] five times. OK is shown in the display during 2 seconds after the reset. This reminder appears after every 30 wash cycles in preset. The number of washes may be varied between 15 and 40 washes.

### 2. Time to change granules

— to maintain the wash power in the machine. The “Washing with granules” button [6] flashes and the message “Change granules Now! See instruction on container” is shown in the display. After changing the granules, reset the reminder by pressing the STOP button [2], wait for 3 seconds, then press the Granule button [6] 5 times. OK is shown in the display during 2 seconds after the reset. A Granule change reminder appears after every 2500 wash cycles. The alarm reset procedure is also written on the Granule container for easy access to the instruction.

### 3. Time for periodical service

– to avoid expensive repairs and unnecessary breakdowns. The STOP button [2] flashes and a message is shown in the display. Either "Time for service 1", "Time for service 2" or "Time for service 3" depending on which service is required. Sequence for service calls are: 1, 2, 1, 3, 1, 2, 1, 3... Phone number for Service company or Granuldisk is shown below the service message. The reminder can be reset by an authorised service technician, once the service is performed. OK is shown in the display during 2 seconds after the reset. Service message appears every 10.000 programs or once every 20 months, whichever occurs first.

#### **Alarm priority**

- "Change wash water" will always have first priority
- Once the water has been changed and the message is reset, the next message can be shown.
- Second priority "Change granules now", "Time for service" are alternately displayed, if issued at the same time.
- The reminders blink until messages are reset.





---

## 4 HACCP Hygiene and Operation Documentation

---

### 4.1 General

Granuldisk Documentation Tool, GDTdirect™, is an integrated function for the documentation of the pot washing machine's operating parameters and critical hygiene control points, HACCP. The following can be viewed:

- Operating data for the last 200 wash program run is viewed directly in the control panel window.
- Download of operating data for the last 200 wash program is available from USB Port. Also available in the exported report are dates for last service intervention and last Granule change (dates when the alarm was reset).
- Accumulated consumption of water and electricity since the start up of the machine.

## 4.2 Reading the data through the control panel

- 1 Press STOP button (2), release it and wait 3 seconds.
- 2 Press "Short program" (4), five times.
- 3 Use button "ECO program" (3) or button "Normal program (5) until you see "read operating data" in the display. Confirm your choice by pressing Confirm button (1).
- 4 Operating data for the last program run is shown in the display;

```
200121 15:19 SG 65/85 OK
```

The information is defined as follows:

- Date; 200121 2020, January, 21st
- Time; 15.19 3.19 p.m
- Program type; E, S, N equivalent to Eco, Short and Normal program
- Washing with granules; indicated by means of a "G", otherwise this box is left blank
- 65; indicates the average temperature in the wash tank during washing.
- 85; indicates the minimum temperature in the rinse tank during rinsing
- OK; indicates that you rinse with volume i.e. full volume (the programs that are preset for this are Short and Normal). "NA" (not applicable) will be shown if you rinse on time, i.e. not the entire volume (the programs that are preset for this are ECO and all COMBI/PLUS modes).



### **NOTE**

*If the wash program has been cancelled due to an operating error or technical error, the temperature indication is not included and "error" plus an error code appears in its place.*

```
200121 15:19 SG Error 103
```

- 5 To view information on program run previously, scroll backwards and forwards in the list using button "ECO program" (3) or button "Normal program" (5).
- 6 To end scrolling and leave the list, press Confirm button (1).
- 7 Press the STOP button (2) to return to operating mode.

## 4.3 Accumulated values for electricity and water consumption

- 1 Repeat steps 1-3 on previous page to enter user menu, but choose "Accumulated power and water" in step 3.
- 2 Accumulated values that are calculated from the operating data are shown. The values have an error margin of approximately 10%.
- 3 Values are presented e.g. as follows:

Accumulated kWh: 125  
Accumulated litres: 256

N.B. If the control board of the machine has been changed, the counter is reset.

## 4.4 Download of operation data from USB Port

- 1 Press STOP.
- 2 Insert a USB stick.

The USB port is found on the right side of the machine.

See Fig. 29 *USB port*



**Fig. 29 USB port**

- 3 Hold ECO and Normal program buttons in for 2 seconds.
- 4 After 10 seconds, function button lights up in green.
- 5 When green light goes out, the USB stick is ready to take out.
- 6 Make sure to close the protective cover cap by pressing it firmly after each use!

---

## 4.5 Optional EcoExchanger®

The EcoExchanger is a heat recovery and steam reduction unit all in one. The unit is condensing the steam and at the same time increasing the temperature on the incoming water (cold) to the rinse tank.

- 1 Press STOP button (2), release it and wait 3 seconds.
- 2 Press "Short program" (4), five times.
- 3 Use button "Eco program" (3) or button "Normal program" (5) until you see "Steam reduction equipment" in the display. Confirm your choice by pressing Confirm button (1).

Here you can scroll and choose steam reduction ON or OFF. The setting will always be in ON mode upon delivery if EcoExchanger has been ordered as an factory fitted option with the machine.

For instructions how to clean the EcoExchanger, see chapter 3.2 Cleaning inside the machine, p 11.



---

## 5 Trouble shooting and alerts

---

### 5.1 User related notices

- User related notices are codes 100, 109, 116, 118, and 132. They appear with a message in the display. Below table gives more details about the user related notices.
- When an alert is displayed, the program is always interrupted.
- After checking and taking care of the problem, the alert can be reset by pressing the STOP button.

<b>Error code</b>	<b>Meaning</b>	<b>Cause</b>	<b>Remedy</b>
<b>100</b>	Spray pipe alarm	Something is preventing movement of the spray pipes.	Remove whatever is preventing movement.
<b>109</b>	Door switch	The doors have accidentally been opened during operation.	Close the door and reset the alarm by pressing the STOP button.
<b>116</b>	Low water level, problem with foam.	Foam forming in the machine	Avoid using detergent designed for washing up by hand. Change the wash water. Contact the detergent supplier if the problems with foam formation still persist. Reset the alarm by pressing the STOP button.

<b>Error code</b>	<b>Meaning</b>	<b>Cause</b>	<b>Remedy</b>
<b>118</b>	Drain valve not closed	The drain valve has opened during an active process in the machine.	Close the drain valve and reset the alarm by pressing the STOP button.
<b>132</b>	Clean level sensor	Level sensor is probably dirty or water is not exchanged after longer shut down period.	Lower the level and clean the level sensor in the wash tank. Refill the tank. If sensor is already cleaned, reset the error and set the machine in heating mode for continued heating



## 5.2 Error codes

The meaning of the error codes can be read out from the table below.

<b>Error code</b>	<b>Meaning</b>	<b>Cause</b>	<b>Remedy</b>
<b>001</b>		Program interrupted by operator.	This error code is displayed only when operating data is read.
<b>101</b>	Motor protector, right wash pump tripped.	The motor is overloaded.	Contact a service engineer!
<b>102</b>	Motor protector, left wash pump tripped.	The motor is overloaded.	Contact a service engineer!
<b>103</b>	Motor protector for rinse pump tripped.	The motor is overloaded, program is interrupted.	Contact a service engineer!
<b>104</b>	Overheating protector for rinse pump tripped, program is interrupted.	The rinse tank heater has overheated.	Clean level sensor. Reset overheat protection. If error code recurs in the next few hours, call a service engineer.
<b>105</b>	Overheating protector for wash tank tripped, program interrupted.	The wash tank heater has overheated.	Clean level sensor. Reset overheat protection. If error code recurs in the next few hours, call a service engineer.
<b>107</b>	Temperature not reached in wash tank	Temperature in wash tank not reached, program interrupted.	Reset the alarm by pressing the STOP button. If the alarm recurs, contact a service engineer.
<b>108</b>	Temperature not reached in rinse tank	Temperature in rinse tank not reached, ongoing process interrupted.	Reset the alarm by pressing the STOP button. If the alarm recurs, contact a service engineer.

<b>Error code</b>	<b>Meaning</b>	<b>Cause</b>	<b>Remedy</b>
<b>110</b>	Temp sensor rinse tank not working.	The temperature sensor in the rinse tank is broken.	Contact a service engineer!
<b>111</b>	Temp sensor wash tank not working	The temperature sensor in the wash tank is broken	Contact a service engineer!
<b>112</b>	Water level too low in rinse tank.	The level in the rinse tank has fallen incorrectly.	Contact a service engineer!
<b>113</b>	Water level too low in wash tank.	The level in the wash tank has fallen incorrectly.	Contact a service engineer!
<b>114</b>	Long wash tank filling time.	Wash tank filling has exceeded its time limit.	Check the water supply to the machine, as well as the rinse pump. Clean the rinse nozzles. Reset the alarm by pressing the STOP button. If the alarm recurs, contact a service engineer.
<b>115</b>	Long rinse tank filling time	Rinse tank filling has exceeded its time limit.	Check the water supply to the machine, as well as the solenoid valve for rinse tank filling. Reset the alarm by pressing the STOP button. If the alarm recurs, contact a service engineer.
<b>117</b>	Long rinse time.	Too long rinse time. Correct water volume has not been reached in time.	Clean the rinse nozzles. Reset the alarm by pressing the STOP button. If the alarm recurs, contact a service engineer.

<b>Error code</b>	<b>Meaning</b>	<b>Cause</b>	<b>Remedy</b>
<b>130</b>	IO board not tested at manufacture.	IO circuit board not tested at manufacture.	Contact a service engineer!
<b>133</b>	Short rinse time.	Rinse water was pumped out too fast, causing insufficient rinsing and heating of the wash ware.	Contact a service engineer!
<b>134</b>	Level detection function in the rinse tank is out of order.	False level signal from one of the level sensors in the rinse tank.	Turn the machine OFF! Continued operation can cause damage to other components. Contact a service engineer!
<b>143</b>	ID error.	Electrical error, identity outside range.	Contact a service engineer!
<b>144</b>	Wrong incoming voltage to IO circuit board.	Wrong incoming voltage to IO circuit board.	Continued operation can cause damage to the machine. Contact a service engineer.



---

## 6 Notes

---